



University Transportation Research Center - Region 2

Final Report



Recommendations for Improving Fire Performance of Steel Bridge Girders

Performing Organization: Manhattan College



May 2018



Sponsor:
University Transportation Research Center - Region 2

University Transportation Research Center - Region 2

The Region 2 University Transportation Research Center (UTRC) is one of ten original University Transportation Centers established in 1987 by the U.S. Congress. These Centers were established with the recognition that transportation plays a key role in the nation's economy and the quality of life of its citizens. University faculty members provide a critical link in resolving our national and regional transportation problems while training the professionals who address our transportation systems and their customers on a daily basis.

The UTRC was established in order to support research, education and the transfer of technology in the field of transportation. The theme of the Center is "Planning and Managing Regional Transportation Systems in a Changing World." Presently, under the direction of Dr. Camille Kamga, the UTRC represents USDOT Region II, including New York, New Jersey, Puerto Rico and the U.S. Virgin Islands. Functioning as a consortium of twelve major Universities throughout the region, UTRC is located at the CUNY Institute for Transportation Systems at The City College of New York, the lead institution of the consortium. The Center, through its consortium, an Agency-Industry Council and its Director and Staff, supports research, education, and technology transfer under its theme. UTRC's three main goals are:

Research

The research program objectives are (1) to develop a theme based transportation research program that is responsive to the needs of regional transportation organizations and stakeholders, and (2) to conduct that program in cooperation with the partners. The program includes both studies that are identified with research partners of projects targeted to the theme, and targeted, short-term projects. The program develops competitive proposals, which are evaluated to insure the most responsive UTRC team conducts the work. The research program is responsive to the UTRC theme: "Planning and Managing Regional Transportation Systems in a Changing World." The complex transportation system of transit and infrastructure, and the rapidly changing environment impacts the nation's largest city and metropolitan area. The New York/New Jersey Metropolitan has over 19 million people, 600,000 businesses and 9 million workers. The Region's intermodal and multimodal systems must serve all customers and stakeholders within the region and globally. Under the current grant, the new research projects and the ongoing research projects concentrate the program efforts on the categories of Transportation Systems Performance and Information Infrastructure to provide needed services to the New Jersey Department of Transportation, New York City Department of Transportation, New York Metropolitan Transportation Council, New York State Department of Transportation, and the New York State Energy and Research Development Authority and others, all while enhancing the center's theme.

Education and Workforce Development

The modern professional must combine the technical skills of engineering and planning with knowledge of economics, environmental science, management, finance, and law as well as negotiation skills, psychology and sociology. And, she/he must be computer literate, wired to the web, and knowledgeable about advances in information technology. UTRC's education and training efforts provide a multidisciplinary program of course work and experiential learning to train students and provide advanced training or retraining of practitioners to plan and manage regional transportation systems. UTRC must meet the need to educate the undergraduate and graduate student with a foundation of transportation fundamentals that allows for solving complex problems in a world much more dynamic than even a decade ago. Simultaneously, the demand for continuing education is growing – either because of professional license requirements or because the workplace demands it – and provides the opportunity to combine State of Practice education with tailored ways of delivering content.

Technology Transfer

UTRC's Technology Transfer Program goes beyond what might be considered "traditional" technology transfer activities. Its main objectives are (1) to increase the awareness and level of information concerning transportation issues facing Region 2; (2) to improve the knowledge base and approach to problem solving of the region's transportation workforce, from those operating the systems to those at the most senior level of managing the system; and by doing so, to improve the overall professional capability of the transportation workforce; (3) to stimulate discussion and debate concerning the integration of new technologies into our culture, our work and our transportation systems; (4) to provide the more traditional but extremely important job of disseminating research and project reports, studies, analysis and use of tools to the education, research and practicing community both nationally and internationally; and (5) to provide unbiased information and testimony to decision-makers concerning regional transportation issues consistent with the UTRC theme.

Project No(s):

UTRC/RF Grant No: 49198-19-28

Project Date: May 2018

Project Title: Recommendations for Improving Fire Performance of Steel Bridge Girders

Project's Website:

<http://www.utrc2.org/research/projects/recommendation-s-improving-fire-performance-steel-bridge-girders>

Principal Investigator(s):

Reeves Whitney, Ph.D., P.E., S.E.

Assistant Professor

Department of Civil and Environmental Engineering

Manhattan College

Riverdale, NY 10471

Tel: (718) 862-7174

Email: reeves.whitney@manhattan.edu

Co Author(s):

Nicole Leo Braxtan, Ph.D.

Department of Civil and Environmental Engineering

UNC Charlotte

9201 University City Blvd.

Charlotte, NC 28223

Email: nbraxtan@uncc.edu

Halima Alsayed

Hardesty & Hanover

5 Marine View Plaza

Hoboken, NJ 07030

Email: halsayed@hardesty-hanover.com

Performing Organization(s):

Manhattan College

Sponsor(s):

University Transportation Research Center (UTRC)

To request a hard copy of our final reports, please send us an email at utrc@utrc2.org

Mailing Address:

University Transportation Research Center

The City College of New York

Marshak Hall, Suite 910

160 Convent Avenue

New York, NY 10031

Tel: 212-650-8051

Fax: 212-650-8374

Web: www.utrc2.org

Board of Directors

The UTRC Board of Directors consists of one or two members from each Consortium school (each school receives two votes regardless of the number of representatives on the board). The Center Director is an ex-officio member of the Board and The Center management team serves as staff to the Board.

City University of New York

Dr. Robert E. Paaswell - Director Emeritus of NY
Dr. Hongmian Gong - Geography/Hunter College

Clarkson University

Dr. Kerop D. Janoyan - Civil Engineering

Columbia University

Dr. Raimondo Betti - Civil Engineering
Dr. Elliott Sclar - Urban and Regional Planning

Cornell University

Dr. Huaizhu (Oliver) Gao - Civil Engineering
Dr. Richard Geddes - Cornell Program in Infrastructure Policy

Hofstra University

Dr. Jean-Paul Rodrigue - Global Studies and Geography

Manhattan College

Dr. Anirban De - Civil & Environmental Engineering
Dr. Matthew Volovski - Civil & Environmental Engineering

New Jersey Institute of Technology

Dr. Steven I-Jy Chien - Civil Engineering
Dr. Joyoung Lee - Civil & Environmental Engineering

New York Institute of Technology

Dr. Nada Marie Anid - Engineering & Computing Sciences
Dr. Marta Panero - Engineering & Computing Sciences

New York University

Dr. Mitchell L. Moss - Urban Policy and Planning
Dr. Rae Zimmerman - Planning and Public Administration

(NYU Tandon School of Engineering)

Dr. John C. Falocchio - Civil Engineering
Dr. Kaan Ozbay - Civil Engineering
Dr. Elena Prassas - Civil Engineering

Rensselaer Polytechnic Institute

Dr. José Holguín-Veras - Civil Engineering
Dr. William "Al" Wallace - Systems Engineering

Rochester Institute of Technology

Dr. James Winebrake - Science, Technology and Society/Public Policy
Dr. J. Scott Hawker - Software Engineering

Rowan University

Dr. Yusuf Mehta - Civil Engineering
Dr. Beena Sukumaran - Civil Engineering

State University of New York

Michael M. Fancher - Nanoscience
Dr. Catherine T. Lawson - City & Regional Planning
Dr. Adel W. Sadek - Transportation Systems Engineering
Dr. Shmuel Yahalom - Economics

Stevens Institute of Technology

Dr. Sophia Hassiotis - Civil Engineering
Dr. Thomas H. Wakeman III - Civil Engineering

Syracuse University

Dr. Baris Salman - Civil Engineering
Dr. O. Sam Salem - Construction Engineering and Management

The College of New Jersey

Dr. Thomas M. Brennan Jr - Civil Engineering

University of Puerto Rico - Mayagüez

Dr. Ismael Pagán-Trinidad - Civil Engineering
Dr. Didier M. Valdés-Díaz - Civil Engineering

UTRC Consortium Universities

The following universities/colleges are members of the UTRC consortium under MAP-21 ACT.

City University of New York (CUNY)
Clarkson University (Clarkson)
Columbia University (Columbia)
Cornell University (Cornell)
Hofstra University (Hofstra)
Manhattan College (MC)
New Jersey Institute of Technology (NJIT)
New York Institute of Technology (NYIT)
New York University (NYU)
Rensselaer Polytechnic Institute (RPI)
Rochester Institute of Technology (RIT)
Rowan University (Rowan)
State University of New York (SUNY)
Stevens Institute of Technology (Stevens)
Syracuse University (SU)
The College of New Jersey (TCNJ)
University of Puerto Rico - Mayagüez (UPRM)

UTRC Key Staff

Dr. Camille Kamga: *Director, Associate Professor of Civil Engineering*

Dr. Robert E. Paaswell: *Director Emeritus of UTRC and Distinguished Professor of Civil Engineering, The City College of New York*

Dr. Ellen Thorson: *Senior Research Fellow*

Penny Eickemeyer: *Associate Director for Research, UTRC*

Dr. Alison Conway: *Associate Director for Education/Associate Professor of Civil Engineering*

Nadia Aslam: *Assistant Director for Technology Transfer*

Nathalie Martinez: *Research Associate/Budget Analyst*

Andriy Blagay: *Graphic Intern*

Tierra Fisher: *Office Manager*

Dr. Sandeep Mudigonda, *Research Associate*

Dr. Rodrigue Tchamna, *Research Associate*

Dr. Dan Wan, *Research Assistant*

Bahman Moghimi: *Research Assistant;*
Ph.D. Student, Transportation Program

Sabiheh Fagigh: *Research Assistant;*
Ph.D. Student, Transportation Program

Patricio Vicuna: *Research Assistant*
Ph.D. Candidate, Transportation Program

1. Report No.	2. Government Accession No.	3. Recipient's Catalog No.	
4. Title and Subtitle Recommendations for Improving Fire Performance of Steel Bridge Girders		5. Report Date May 2018	6. Performing Organization Code
7. Author(s) Reeves Whitney , Ph.D., P.E., S.E Nicole Leo Braxton, Ph.D. Halima Alsayed		8. Performing Organization Report No.	
9. Performing Organization Name and Address Dept. of Civil & Environmental Engineering Manhattan College 4513 Manhattan College Parkway Riverdale, NY 10471		10. Work Unit No.	11. Contract or Grant No. 49198-19-28
12. Sponsoring Agency Name and Address University Transportation Research Center 160 Convent Avenue, Marshak 910 New York, NY 10031		13. Type of Report and Period Covered Final, Sept 1 2016 - May 31, 2018	
15. Supplementary Notes		14. Sponsoring Agency Code	
16. Abstract Infrastructure risk due to fire has been well documented. In particular, bridges in the urban environment are susceptible due to low overhead clearances on overpasses, existing simple spans with no redundancy, due to low overhead clearances on overpasses, existing simple spans with no redundancy, narrow lane widths and general alignment congestion. Although the risk is significant, the current AASHTO Bridge Design Specification does not include provisions for design due to fire conditions. As such, this paper considers alternatives for improving the fire resistance of steel bridges using both traditional and nontraditional fire protection methods. In this paper, a total of eight parameters are investigated: (1) global section factor (W/D ratio) of bridge girder cross-section; (2) thickness of the flange; (3) thickness of the web; (4) steel material specification; (5) concrete slab width; (6) concrete slab thickness; (7) thickness of intumescent paint; and (8) thickness of SFRM. It is shown that the temperature domain performance can be significantly increased by (1), (3), (7), and (8) while the other parameters are less effective. The recommendations from this research can be readily implemented in both bridge design and retrofit scenarios.			
17. Key Words Fire resistance, steel bridge girders, fire protection		18. Distribution Statement	
19. Security Classif (of this report) Unclassified	20. Security Classif. (of this page) Unclassified	21. No of Pages 15	22. Price

Disclaimer

The contents of this report reflect the views of the authors, who are responsible for the facts and the accuracy of the information presented herein. The contents do not necessarily reflect the official views or policies of the UTRC or the Federal Highway Administration. This report does not constitute a standard, specification or regulation. This document is disseminated under the sponsorship of the Department of Transportation, University Transportation Centers Program, in the interest of information exchange. The U.S. Government assumes no liability for the contents or use thereof.

Recommendations for Improving Fire Performance of Steel Bridge Girders

Reeves Whitney¹, Ph.D., P.E., S.E., Nicole Leo Braxtan², Ph.D., Halima Alsayed³

¹ Dept. of Civil & Env. Engineering, Manhattan College, 4513 Manhattan College Parkway, Riverdale, NY 10471. (Corresponding author). reeves.whitney@manhattan.edu

² Dept. of Civil & Env. Engineering, UNC Charlotte, 9201 University City Blvd. Charlotte, NC 28223. nbraxtan@uncc.edu

³ Hardesty & Hanover, 5 Marine View Plaza, Hoboken, NJ 07030. halsayed@hardesty-hanover.com

NOTE: FOR THE PUBLISHED VERSION OF THIS ARTICLE PLEASE GO [HERE](#)

ABSTRACT

Infrastructure risk due to fire has been well documented. In particular, bridges in the urban environment are susceptible due to low overhead clearances on overpasses, existing simple spans with no redundancy, narrow lane widths, and general alignment congestion. Although the risk is significant, the current AASHTO Bridge Design Specification does not include provisions for design due to fire conditions. As such, this paper considers alternatives for improving the fire resistance of steel bridges using both traditional and non-traditional fire protection methods. In this paper, a total of eight parameters are investigated: (1) global section factor (W/D ratio) of bridge girder cross-section; (2) thickness of the flange; (3) thickness of the web; (4) steel material specification; (5) concrete slab width; (6) concrete slab thickness; (7) thickness of intumescent paint; and (8) thickness of SFRM. It is shown that the temperature domain performance can be significantly increased by (1), (3), (7), and (8) while the other parameters are less effective. The recommendations from this research can be readily implemented in both bridge design and retrofit scenarios.

INTRODUCTION

Steel girder bridges are commonly used for highways, railroads, or footbridges and are often designed compositely with a concrete deck slab. This type of system is used in both long and short span applications worldwide and represents an economical bridge engineering solution. Bridges are a vital component of the infrastructure that are necessary for public welfare and emergency response. Therefore, their designs should consider the risks associated with extreme events, including earthquakes, fire hazards and others. Fire hazards have not typically been considered in bridge design, although it has been well established as design criteria for buildings. Lee et al. (2013) conducted a study on bridge failures in which they reviewed 1254 bridge failures, 1062 of which occurred in North America from 1980 to 2012. The main cause of failure was flooding, accounting for 28.3% of all failures. Additionally, 2.8% of bridge failures occurred due to fire while 1.9% of failures were due to earthquakes. Earthquakes have long been established as design criteria for bridges although they accounted for fewer failures than fire. Of the failed bridges due to fire, 45% were constructed of steel and 50% resulted in a total collapse of the

structure (Lee et al. 2013). Further, the literature has shown that bridges are extremely vulnerable to fire hazards (Alos-moya et al. 2014, Kodur et al. 2013, Gong and Agrawal 2015 & 2016, Garlock et al. 2012 and Wright et al. 2013). Since the failure of a bridge creates a public welfare disturbance, fire risk needs to be addressed in bridge design practice for critical infrastructure.

There are extensive building codes for the fire protection of buildings such as the International Building Code (IBC) 2015, which follows test procedures from American Society for Testing and Materials (ASTM) E119 and Underwriters Laboratories (UL) 263 to design for structural fire resistance. Additionally, the American Society of Civil Engineers (ASCE) included Appendix E: Performance-Based Design Procedures for Fire Effects on Structures in the 2016 edition of ASCE 7: Minimum Design Loads for Buildings and Other Structures (ASCE 2016). National Fire Protection Association (NFPA) includes standard codes of practice for fire resistance of buildings. On the other hand, there are no specific fire resistance requirements in The American Association of State Highway and Transportation Officials (AASHTO) Bridge Design Specifications or other U.S. bridge design standards.

Bridge fire exposure can originate from hydrocarbon fires caused by the collision of a vehicle carrying a large fuel load. These hydrocarbon fires, detailed in Eurocode and ASTM 1529: Standard Test Methods for Determining Effects of Large Hydrocarbon Pool Fires on Structural Members and Assemblies, are characterized by a rapid development of high temperatures up to 1100 °C in about 15 minutes. Bridges may also be susceptible to lower intensity fires resulting from nearby structures, or smaller vehicles, which may be adequately characterized by the ASTM E119 fire curve (or Eurocode's "External" fire), which has historically been used for buildings.

A range of parameters influencing the fire performance of bridge girders was considered and classified as either traditional or non-traditional methods. Traditional fire protection methods are either passive or active. Active systems include sprinklers and suppression systems, which require a sensor network to identify a fire event and mechanical/plumbing systems to provide the suppression. The long-term maintenance and upkeep of these systems combined with low the effectiveness of sprinkler and suppression systems outside of compartment fires precludes their use in bridges. Thus, passive systems are more appropriate for bridges and may have lower long-term maintenance costs. A common method is the practice of coating members with fireproofing materials. These materials include cementitious coatings, intumescent paints and spray applied fire resistive material (SFRM). Intumescent paints are effective as the coating expands and chars upon temperature increase which creates an insulating layer slowing the rate of temperature increase of the internal steel member. SFRMs are typically composed of gypsum or cement along with other additives. Their inherent thermal properties provide higher fire resistance than bare steel. Since they are spray applied, detailed features such as bolts and connections can be easily covered. However, in the case of bridge application consideration should be given to the influence of external environmental conditions.

Non-traditional methods of passive protection can also be considered. Some non-traditional methods include modifying the geometry of the cross section and using different steel specifications to lower the rate of temperature increase. The geometry of the cross section plays an important role in heat transfer since the rate of temperature increase is related to the member volume and related element thickness. By increasing the width or thickness of certain elements in the cross section, the temperature increase may be reduced. Considering different steel specifications will change the thermal properties and may lead to lower temperature and a higher fire rating. These methods will be evaluated for degree of effectiveness.

The main goal of this paper is to discuss some critical parameters of steel girder bridges exposed to fire. Eight parameters were considered in this study: (1) global section factor (W/D ratio) of bridge girder cross-section; (2) thickness of the flange; (3) thickness of the web; (4) steel material specification; (5) concrete slab width; (6) concrete slab thickness; (7) thickness of intumescent paint; and (8) thickness of SFRM. The results from (1) are used as a baseline for the rest of the parameters to illustrate the improvement in fire performance. It will be shown that the temperature domain performance can be significantly increased from baseline (1) by (3), (7), and (8) while the other parameters are less effective. The recommendations from this research can be readily implemented in both bridge design and retrofit scenarios.

METHOD

The numerical modeling was performed using Abaqus (Dassault Systemes 2013) finite element analysis software. A typical cross-section is shown on Fig. 1, which has a composite concrete slab of 128 cm width and 13 cm thickness in addition to the steel beam. Fig. 2 shows the cross-section from the Abaqus model where DC2D4 4-node linear heat transfer elements were used for the finite element mesh. Temperature histories were applied to the outer surfaces of the cross-section corresponding to ASTM E119 and Eurocode (CEN 2002) Hydrocarbon fires (Fig. 3). Nodal temperatures from the numerical models were compared to rating thresholds from ASTM E119 and ASTM E1529 for the E119 and Hydrocarbon fires, respectively. Table 1 contains the threshold temperatures for determining the prescriptive “rating” of the system. The time until these threshold temperatures are reached on the cross-section, either peak nodal temperature, or average temperature over the cross-section, determines the “rating” of the system. Ten hot rolled cross-sections of carbon steel covering a typical range of weight (W) to heated perimeter (D) ratio, W/D, were selected as shown in Table 2. Depths ranged from 12 to 36 in, while weight ranged from 36 to 395 pounds per foot. W/D ratio is well known to represent the resistance of a steel cross-section to temperature increase (Buchanan and Abu 2017).

The heat transfer model considers conduction, convection and radiation. For conduction, the heat equation (1) shows that the rate of temperature change is proportional to the thermal diffusivity (Bergman et al. 2011). The thermal diffusivity is a function of the conductivity, specific heat, and density which must all be defined for the elements of the cross-section. The values for specific heat and conductivity are adopted from Eurocode (CEN 2004, 2005) and are shown on Fig. 4 and Fig. 5, respectively, for both carbon steel and concrete.

$$\frac{\partial T}{\partial t} = \alpha \nabla^2 T \quad (1)$$

Where:

$$\alpha = \text{thermal diffusivity} = \frac{k}{C_p \cdot \rho} \text{ (m}^2\text{/s)}$$

$$C_p = \text{Specific Heat (Jkg}^{-1}\text{K}^{-1}\text{)}$$

$$k = \text{Thermal Conductivity (Wm}^{-1}\text{K}^{-1}\text{)}$$

$$\rho = \text{Density (kg}\cdot\text{m}^{-3}\text{)}$$

For convection, the heat flux is given by (2), which depends on a convection coefficient and the temperature difference between the fluid and surface (Bergman et al. 2011). The convection coefficients used in the analysis are shown on Fig. 6 (CEN 2002).

$$q_{\text{conv.}} = h(T_f - T_s) \quad (2)$$

Where:

- $q_{\text{conv.}}$ = convection heat flux (Wm^{-2})
- h = convection coefficient ($\text{Wm}^{-2}\text{K}^{-1}$)
- T_f = temperature of the fluid (K)
- T_s = temperature of the surface (K)

For radiation, the heat flux is given by (3) and depends on the surface emissivity, Stefan-Boltzmann constant, and the temperature difference between the surface and fluid (Bergman et al. 2011). For the bare steel beam, the emissivity used in the analyses are shown on Fig. 6 (Kodur et al. 2013).

$$q_{\text{rad}} = \varepsilon \sigma (T_s^4 - T_f^4) \quad (3)$$

Where:

- q_{rad} = radiation heat flux (Wm^{-2})
- ε = emissivity
- σ = Stefan - Boltzmann constant, $5.67\text{e-}08$ ($\text{Wm}^{-2}\text{K}^{-4}$)

The thermal properties used in the analysis have all been defined for the typical cross-section used for Parameter 1. Thermal properties will be changed while investigating the additional parameters and will be discussed within the results section for those cases.

The numerical analysis used in this paper, which matches those used by others (Kodur et al. 2013, Cedeno et al. 2011, and Gong and Agrawal 2015), was verified by comparing results to experimental data. The test by Wainman et al. (1987), consisted of heating a steel beam with concrete slab in a furnace while four point loads were applied at different locations (1/8, 3/8, 5/8, and 7/8 span). The beam had a span of 4.53 m with steel beam depth of 26 cm and 15 cm flange width, and the concrete slab was 64 cm wide by 13 cm thick. The furnace gas temperature used in the test is shown on Fig. 7. Temperature results are presented for the top flange, bottom flange and web for both the experimental and numerical methods. Good agreement can be seen between the two datasets. Table 3 contains a comparison of the numerical and experimental temperatures obtained after 50 min duration. From Table 3, the maximum error is ~ 7%, which may be considered reasonable. In addition, the verification study produced similar results to those presented by Cedeno et al. (2011). Hence the proposed method has been validated for heat transfer analysis of steel beams with concrete slabs.

RESULTS AND DISCUSSION

Parameter 1 – Effect of W/D

The first parameter studied is the effect on W/D ratio on the fire rating of the cross-sections considering both peak and average temperature thresholds. Fig. 8 contains the results for all 10 cross-sections and linear regressions for the peak and average ratings of each fire curve. It can be seen from Fig. 8 that the peak temperature threshold controls for all cases and thus will be the only threshold presented for the remainder of this paper. Also, a strong linear trend can be observed from the regressions shown on Fig. 8 with the lowest $R^2 \approx 0.98$. This is also the case for the other results presented in this work thus only the linear regressions will be presented. The results from

the E119 fire show that typical unprotected steel bridge girders are expected to have rating from about 15 to 35 minutes. On the other hand, with a hydrocarbon fire, the expected rating is only about 5 to 10 minutes. For comparison, a similar system in a building may require a rating of 1-3 hours, depending on occupancy, to satisfy the Code requirements. The low rating for the hydrocarbon fire underscores the vulnerability of typical steel girder bridges. Using the regression equations on Fig. 8, W/D ratio can be used as design criteria which is commonly done in buildings to achieve a certain rating. Hence selecting a steel girder with the same section properties (Z_x , I_x , etc.) but a higher W/D will inherently increase the fire resistance.

Parameters 2 & 3 – Thickness of the Flange and Web

Parameter 2 investigates the effect of the flange thickness on the rating of the cross-section. Using the cross-sections from Parameter 1 as a baseline, the thickness of the flange is increased based on the original flange thickness. Increase of “+1 Δ ” is made by increasing the flange thickness by 6.35 mm for $t_f \leq 25.4$ mm, 12.7 mm for $25.4 \text{ mm} < t_f < 50.8$ mm, and 19.05 mm for $t_f \geq 50.8$ mm. The flange thickness was also increased by “+2 Δ ”, simply twice the “+1 Δ ” increase. Fig. 9 contains the results for the rating based on the “Original” model (Parameter 1 results) and the “+1 Δ Modified” and “+2 Δ Modified” models. It can be seen from the figure that there is only a slight increase in the rating for both the E119 and Hydrocarbon fires when modifying the flange thickness and basing ratings on the threshold temperatures specified. For the E119 fire, the higher W/D sections show a slight increase but with W/D less than about 2, it is negligible. For the Hydrocarbon fire there is negligible increase across the entire W/D range.

Parameter 3 investigates the effect of the web thickness (t_w) on the rating of the cross-section. The procedure is the same as Parameter 2, where the “Original” models correspond to those from Parameter 1. Increase of “+1 Δ ” is made by increasing the web thickness by 6.35 mm for $t_w \leq 25.4$ mm, 12.7 mm for $25.4 \text{ mm} < t_w$. The web thickness was also increased by “+2 Δ ”, simply twice the “+1 Δ ” increase. Fig. 10 contains the results for the rating based on the “Original” model (Parameter 1 results) and the “+1 Δ Modified” and “+2 Δ Modified” models. From Fig. 10, a significant increase in rating across the entire W/D range for both fire types can be seen. Thus, increasing the web thickness is more effective than increasing the flange thickness. This is because the fire is applied to the entire exposed surface of the beam and since the web is the thinnest element in a rolled section, it has the lowest resistance to temperature change. Fig. 11 shows the temperature histories for the elements of the cross-section of a W36x135 under hydrocarbon fire curve. Fig. 11 shows that the web has higher temperatures than both bottom and top flanges. Hence the web controls for the ratings shown for Parameter 1 and increasing its thickness is an effective means of increasing the rating. This result is useful since increasing the web thickness is possible in both new bridge design and retrofit scenarios. Fig. 12 presents web thickness vs fire rating for all the cross-sections considered. The results are more useable in this fashion since the rating may be readily determined based on the web thickness alone. If the web thickness is increased such that it exceeds the thickness of the flanges, particularly the bottom flange, the web may not be the controlling element. This may be easily seen from Fig. 11 since the bottom flange temperature is close to the web temperature. For the W36x135 cross-section, the flange is only 30% thicker than the web, which is on the lower end for rolled sections. Thus the bottom flange thickness must also be considered when increasing the web thickness so it does not become the controlling element. The results for Parameter 3 may be readily used to improve fire performance by increasing the web thickness.

Parameter 4 – Steel Material Specification

Parameter 4 investigates changing the steel specification from carbon steel to weathering steel (4a), fire resistant (FR) steel (4b) and austenitic steel (4c). Weathering steel is commonly used in bridge construction today with austenitic steel being less common. Fire resistant steels are still relatively new and are rare in bridge designs. Since all three of the materials are viable alternatives for traditional carbon steel, this parameter will investigate if simply changing the material type has an impact on the fire rating.

In order to perform the heat transfer analysis, new temperature dependent values for specific heat and conductivity are required for the three new materials. The emissivity and convection coefficients are modeled identical to Parameter 1. Figs. 13 and 14 contain the plots for weathering steel. Although mechanical properties under elevated temperature are available in Garlock et al. (2013), the authors were unable to locate literature on the thermal properties above 600 °C (Cor-ten 2014). Due to this lack of published thermal properties they were extrapolated to 1200 °C in order to cover the entire range of fire temperatures (Fig. 14). It can be seen from the Figs. 13 & 14 that both conductivity and specific heat for weathering steel closely matches the behavior of carbon steel. The exception is the spike seen in the carbon steel plots at ~ 700 °C, due to the phase change. For FR steel, we used the “590 MPa Nippon Steel” (Mizutani et al. 2004) properties which are shown on Figs. 15 to 16 and are taken from (Ding et al. 2004). The conductivity and specific heat trends are again similar to carbon steel. One of the main benefits of FR steel, although not included in this analysis, is that the yield strength reduces at a slower rate under elevated temperatures compared to carbon steel. Analyses in the strength domain will undoubtedly see some benefit to the use of FR steel over carbon steel. For austenitic steel we used AISI A316 with thermal properties shown on Figs. 17 and 18, taken from Mills et al. (2004). The conductivity is dramatically lower than carbon steel below about 900 C. Figs. 19 – 20 present the results for FR and austenitic steel. The results for weathering steel are not shown because the results are so close to the carbon steel values that the trendlines are overlapping (similar to FR, Fig. 18). In Fig. 18 austenitic steel has a lower rating than carbon steel despite its lower conductivity below 900 °C. This can be explained by examining the thermal diffusivity which is shown in Eq. (1) to be proportional to the rate of temperature change and shown on Fig. 21. The diffusivity of carbon steel dips below austenitic steel and remains below during the 649 °C to 704 °C threshold temperatures for Hydrocarbon and E119 fires, respectively. This dip is explained by the dramatic increase in specific heat of carbon steel (Fig. 3) due to the phase change. This illustrates that the results may be somewhat sensitive to the specific heat curve specified in the analysis. There are other models accepted in the literature in addition to the Eurocode model used in this paper, see Kodur et al. (2010) for a comparison of the other models. The research team concluded that by considering only the temperature domain rating, there is no benefit from changing the material specification and that the comparison may be affected by the specific heat model used for carbon steel.

Parameter 5 & 6 – Concrete Slab Dimensions

For Parameters 5 and 6 the concrete slab thickness and width were modified, respectively. The slab thickness was increased from 13 cm to 15.2 cm (“+1 Δ ”) and then to 18.3 cm (“+2 Δ ”). The slab width was increased from 128 cm to 152 cm (“+1 Δ ”) and then to 183 cm (“+2 Δ ”). From

Fig. 22 and 23 there is little effect on the ratings when changing slab thickness or width. This confirms that the heat transfer is dominated by the steel cross-section and the slight increase in rating that is shown can be attributed to an increase in the heat sink effect provided by the concrete slab. Neither parameter is effective in increasing the fire resistance.

Parameters 7 & 8 – Passive Protection – Intumescent Paint, SFRM

Passive protection has been used for decades in building structures and has proven to be a cost-effective fire protection method (Buchanan and Abu 2017). Although active protection measures, such as sprinklers and suppression systems, may be applied to building applications, the lack of a defined compartment in a bridge fire scenario precludes their use. Thus, passive protection may be the only form, of the existing technologies, applicable for bridges. Spray applied fire resistive material (SFRM) are compounds composed of gypsum and cement which are applied the surface of the steel bridge girder. Intumescent paint (I.P.) expands with heat exposure thus increasing volume and lowering the density of the protective paint. Their inherent thermal conductivity, ~2 orders lower than steel, slows the rate of temperature increase and thermally insulates the underlying steel.

The specific heat and thermal conductivity for I.P. is taken from the study by Krishnamoorthy & Bailey (2009). They determined the conductivity for a variety of proprietary paints and presented equations for the average values. These equations, however, were not reported to enough significant figures and therefore updated regression expressions with sufficient accuracy are given by Eq. 4 and 5.

For $20^{\circ}\text{C} < T < 350^{\circ}\text{C}$:

$$k = (-1.62 \times 10^{-8}) T^3 + (1.201 \times 10^{-5}) T^2 - 0.002902T + 0.2759 \quad (4)$$

For $350^{\circ}\text{C} < T < 1000^{\circ}\text{C}$:

$$k = (-4.11 \times 10^{-10}) T^3 + (1.3402 \times 10^{-8}) T^2 - 0.0011196T + 0.28682 \quad (5)$$

Specific heat and conductivity for the SFRM are taken from Bentz and Prasad (2007) considering a high-density SFRM, which is most appropriate for exterior steel components exposed to the environment. Low-density SFRM is undesirable for bridge applications due to its lower durability under exposure. Thermal conductivity and specific heat are shown on Fig. 24 and 25, respectively, for both SFRM and I.P. In addition to the thermal properties of the coating, the emissivity shown in Fig. 6 must be revised since the fire is now acting on the surface coatings instead of the bare steel. Table 4 gives the new values for emissivity defined over the cross-section. The emissivity of the bottom flange is based on literature for I.P. (Krishnamoorthy & Bailey, 2009) and the assumption that SFRM is largely a cementitious material. The emissivity of the web and top flange are then varied to account for impact of the fire over the height of the member (Kodur, et al., 2013).

For this parameter, the required minimum thickness of SFRM and I.P. vs W/D ratio to achieve a 1-hour rating under the hydrocarbon fire is presented. SFRM and I.P. coatings are applied only to the steel surface and not to the concrete slab in this study. The thicknesses are determined by iteration, until the threshold temperatures are met at 1-hour. Figs. 26 and 27 contain the regression equations for the required thickness, over three ranges of W/D: “low”, “mid”, and “high”. The limits for each range is given below (6):

$$W/D_{\text{low}} < 1.274; \quad 1.274 \leq W/D_{\text{mid}} \leq 2.036; \quad W/D_{\text{high}} > 2.036 \quad (6)$$

Hence both SFRM and I.P. provide effective means of increasing the bridge fire rating to 1-hr. Passive protection may be applied to both new and existing bridges, making them a plausible method of increasing the fire resistance of critical infrastructure. Additional research on the durability of these materials should also be considered.

CONCLUSION

This paper presents a review of the thermal properties required to determine a bridge fire rating in the temperature domain. Various parameters have been considered in order to determine which are effective in increasing the fire rating of a bare steel bridge girder based on prescribed temperature thresholds. It has been shown that of the non-traditional parameters, increasing the web thickness, which is the thinnest element in the cross-section, is effective for both new design and retrofit scenarios. Traditional methods of fire protection including SFRM and I.P. coatings have also been considered and shown to be effective. This paper presents minimum thickness requirements to achieve a 1-hr rating under a hydrocarbon fire. These recommendations are valid for both new bridge designs and retrofits since passive protection can be applied in both cases. It has been shown that alternative steel materials and changing the concrete slab thickness have negligible impact on the temperature domain rating of the structure.

ACKNOWLEDGEMENTS

The research presented in this paper was supported by the University Transportation Research Center (UTRC) through Grant #49198-19-28.

FIGURES

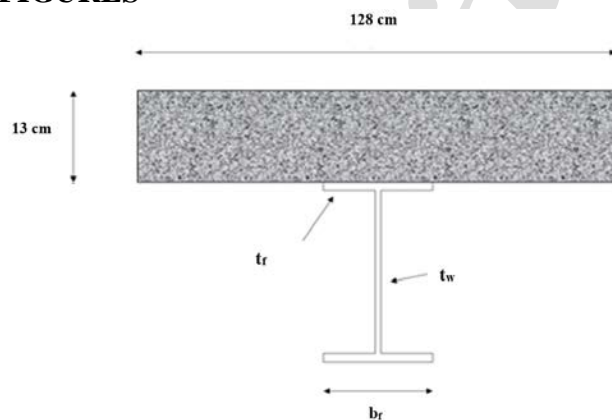

Fig. 1. Typical Cross-Section

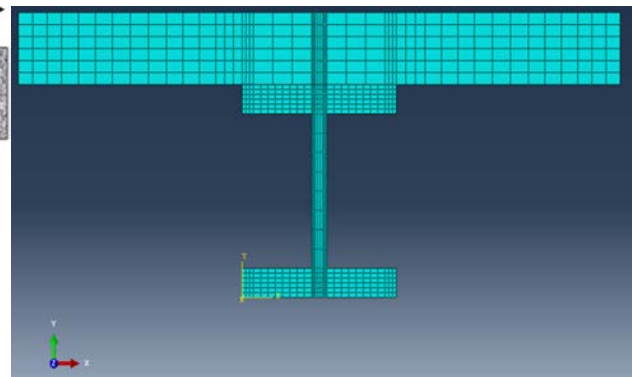

Fig. 2. Abaqus model of cross-section

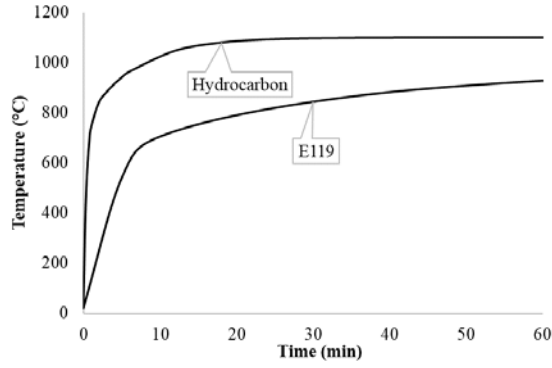

Fig. 3. E119 and Hydrocarbon Fire Curves

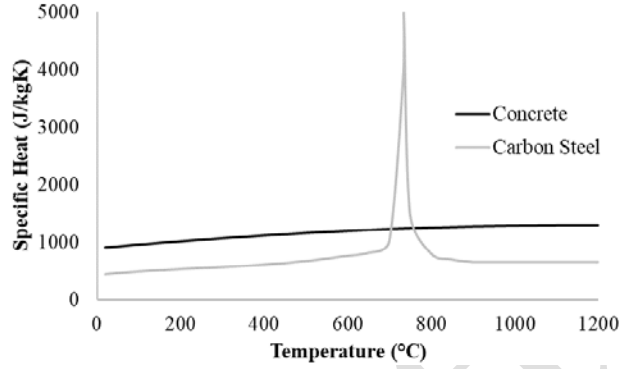

Fig. 4. Specific Heat

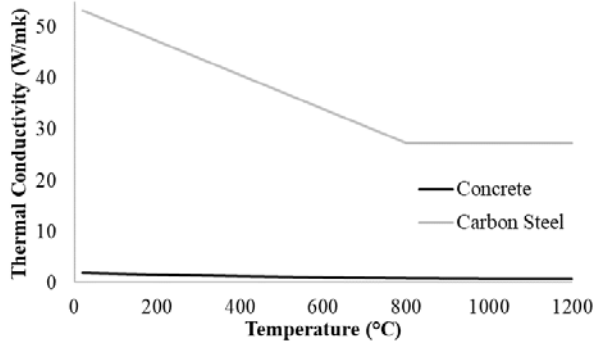

Fig. 5. Conductivity

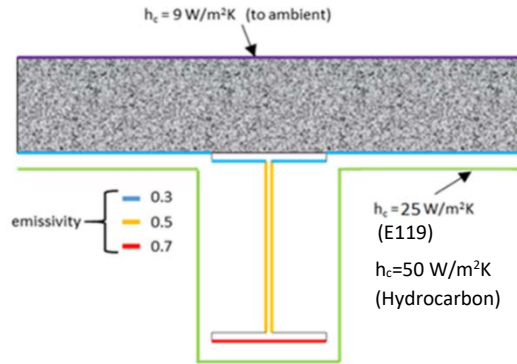

Fig. 6. Emissivity and Convection Coefficients

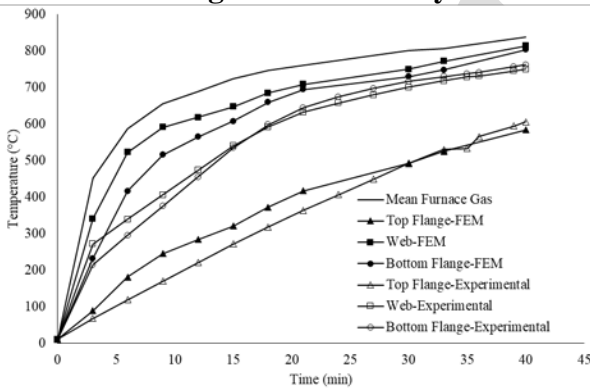

Fig. 7. Numerical analysis validation

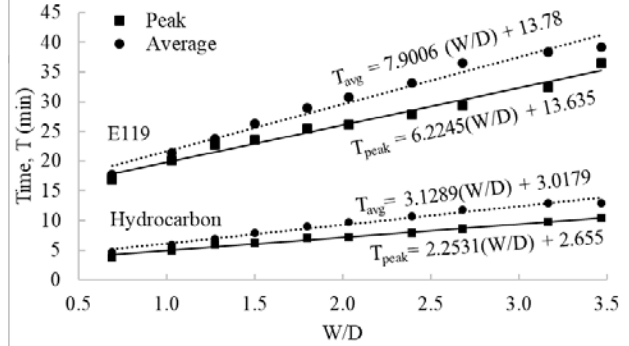

Fig. 8. Parameter 1 - Rating vs. W/D

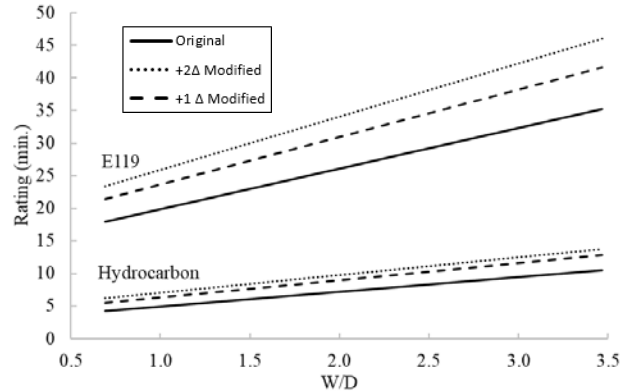
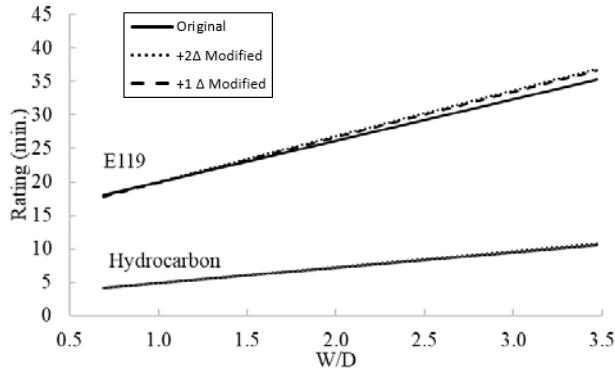

Fig. 9. Parameter 2 - Rating vs. W/D

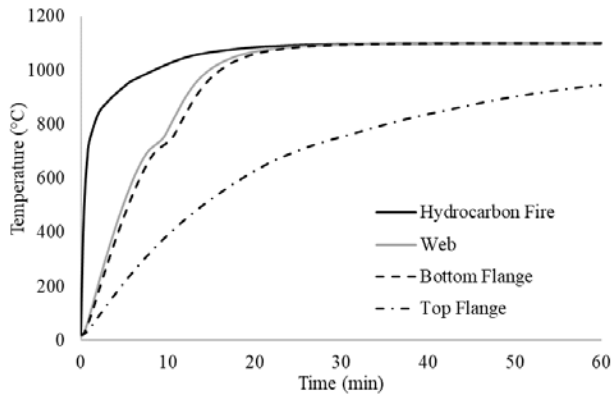

Fig. 10. Parameter 3 - Rating vs. W/D

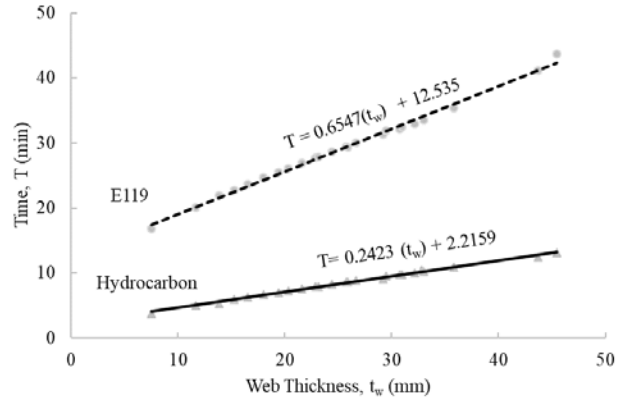

Fig. 11. Temp. vs. time for W36x135

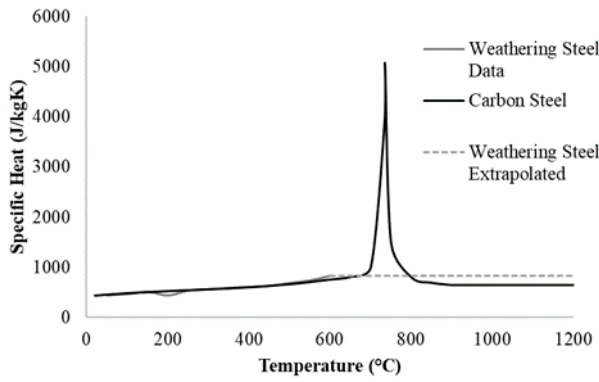

Fig. 12. Rating vs. web thickness

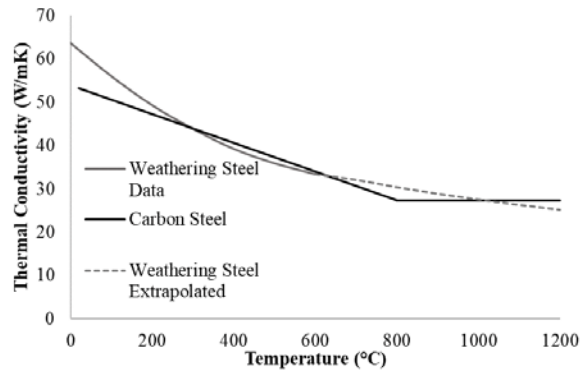

Fig. 13. Specific Heat – Weathering Steel

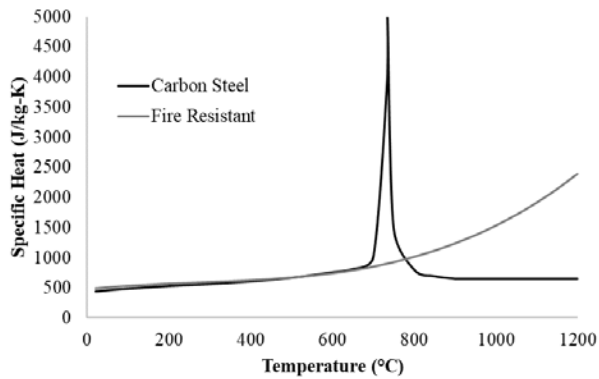

Fig. 14. Conductivity – Weathering Steel

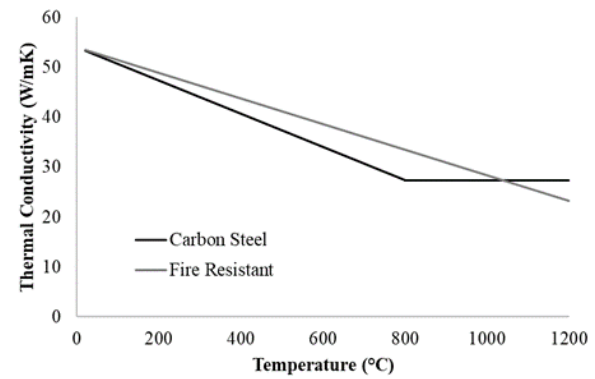

Fig. 15. Specific Heat – FR Steel

Fig. 16. Conductivity – FR Steel

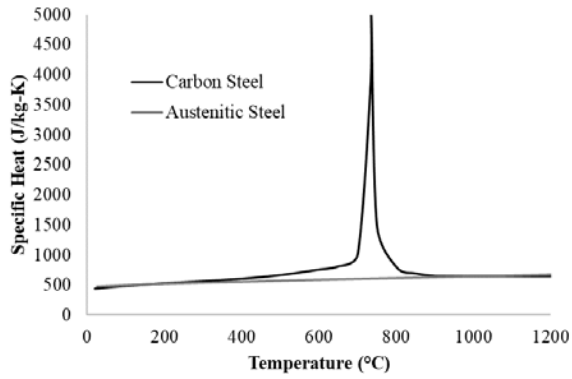

Fig. 17. Specific Heat – Austenitic Steel

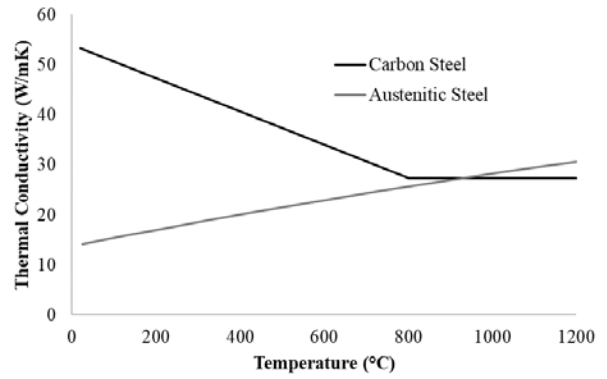

Fig. 18. Conductivity – Austenitic Steel

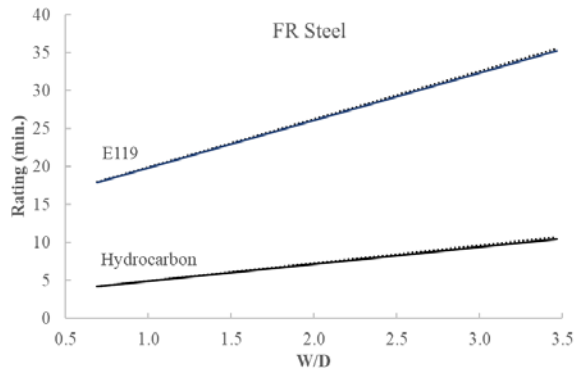

Fig. 19. Parameter 4b - Rating vs. W/D

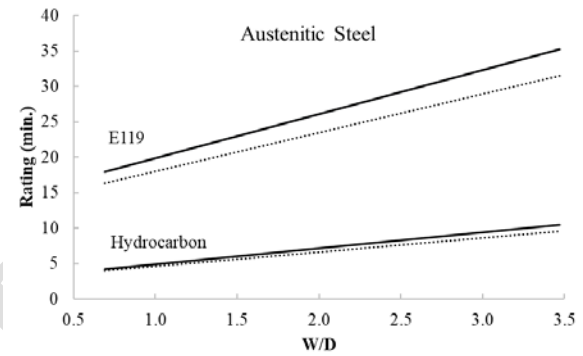

Fig. 20. Parameter 4c - Rating vs. W/D

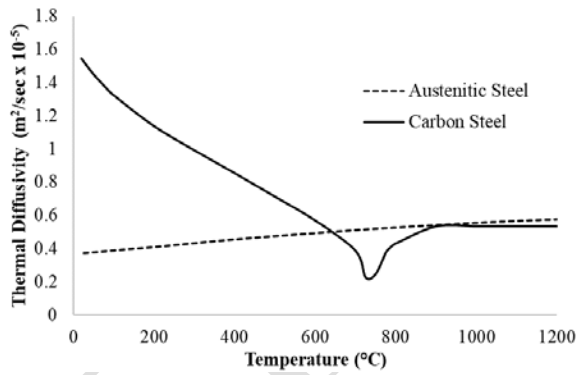

Fig. 21. Diffusivity comparison

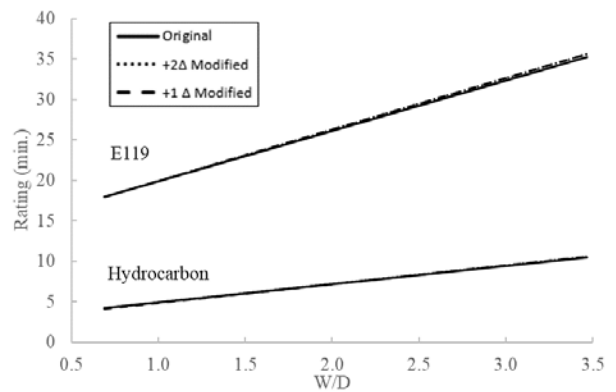

Fig. 22. Parameter 5 - Rating vs. W/D

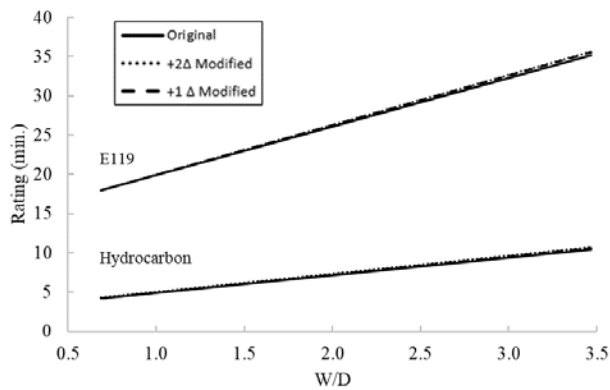

Fig. 23. Parameter 6 - Rating vs. W/D

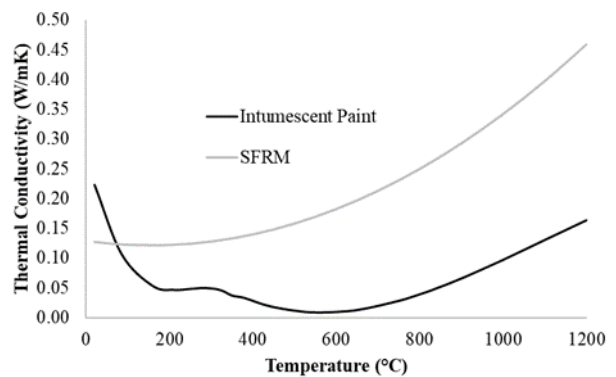

Fig. 24. Conductivity - SFRM and IP

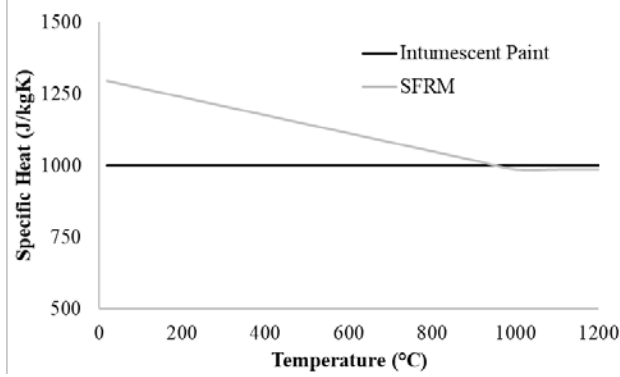

Fig. 25. Specific Heat - SFRM and IP

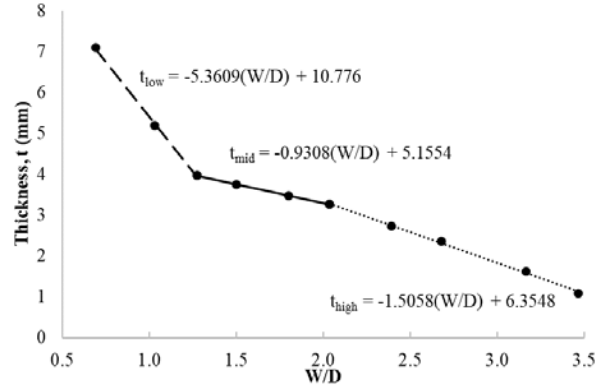

Fig. 26. Parameter 7 – IP Thickness vs. W/D

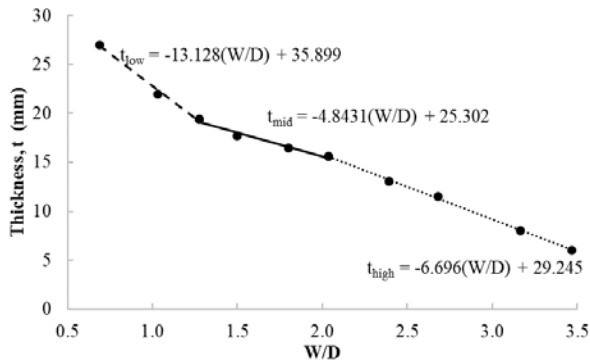

Fig. 27. Parameter 8 – SFRM Thickness vs. W/D

TABLES

Table 1. Rating Criteria

Criteria	ASTM E119	ASTM E1529
Average Temp.	593° C	538°C
Peak Temp.	704°C	649°C

Table 2. Test Matrix

Beam	W/D Ratio	h/t _w Ratio	b _f /2t _f Ratio	t _f (m)	t _w (m)
W16x36	0.690	48.10	8.12	0.0109	0.0075
W27x84	1.030	52.70	7.78	0.0163	0.0117
W36x135	1.274	54.10	7.56	0.0201	0.0152
W36x160	1.500	49.90	5.88	0.0259	0.0165
W36x194	1.800	42.40	4.81	0.0320	0.0194

W36x247	2.036	40.10	6.11	0.0343	0.0203
W27x235	2.394	26.20	4.41	0.0409	0.0231
W36x330	2.679	31.40	4.49	0.0470	0.0259
W36x395	3.166	26.30	3.83	0.0559	0.0310
W12x230	3.468	7.56	3.11	0.0526	0.0328

Table 3. Temperatures at 50 minutes (°C), numerical vs. experimental results

Location	Experimental	Numerical
Top Flange	606	586 (-3.3%)
Web	749	802 (+7.1%)
Bottom Flange	762	812 (+6.6%)

Table 4. Emissivity for SFRM and I.P. Coatings

Surface	Emissivity - SFRM	Emissivity - I.P.
Concrete Slab	0.3	0.425
Top Flange	0.385	0.425
Web	0.643	0.625
Bottom Flange	0.9	0.825

REFERENCES

Alos-Moya, J., Paya-Zaforteza, I., Garlock, M.E.M., Loma-Ossorio, E., Schiffner, D., and Hospitaler, A. (2014). "Analysis of a Bridge Failure Due to Fire Using Computational Fluid Dynamics and Finite Element Models." *Engineering Structures*, 68, 96-110.

American Society of Civil Engineers (2016). *Minimum Design Loads for Buildings and Other Structures (ASCE/SEI 7-16)*, Reston, Virginia; 2016.

ASTM International (2016). *ASTM E119: Standard Test Methods for Fire Tests of Building Construction and Materials*. West Conshohocken, PA; 2016.

ASTM International (2016). *ASTM E1529: Standard Test Methods for Determining Effects of Large Hydrocarbon Pool Fires on Structural Members and Assemblies*. West Conshohocken, PA; 2016.

- Bentz D. & Prasad K. (2007). Thermal Performance of Fire Resistive Materials I. Characterization with Respect to Thermal Performance Models. NISTIR 7401. NIST.
- Bergman, T. L., Adrienne, S. L., Incropera, F. P., DeWitt, D. P. (2011). Fundamentals of Heat and Mass Transfer, 7th edition, Wiley, Hoboken, NJ.
- Buchanan, A. H., A. K. Abu. (2017). Structural Design for Fire Safety, 2nd Edition, Wiley, West Sussex, UK.
- Cedeno, G., Varma, A., and Gore, J. (2011) Predicting the Standard Fire Behavior of Composite Steel Beams. Composite Construction in Steel and Concrete VI: pp. 642-656.
- Cor-Ten™ Product Literature (2014), Nippon Steel & Sumitomo Metal Corporation. http://www.nssmc.com/product/catalog_download/pdf/A006en.pdf
- Dassault Systèmes. (2013). “Abaqus 6.13 Online Documentation”. Vélizy-Villacoublay, France.
- Jun Ding, Guo-Qiang Li, Y. Sakumoto, Parametric studies on fire resistance of fire-resistant steel members, Journal of Constructional Steel Research, Volume 60, Issue 7, 2004, Pages 1007-1027, ISSN 0143-974X, <http://dx.doi.org/10.1016/j.jcsr.2003.09.007>.
- European Committee for Standardization (CEN). (2002). “Actions on structures. Part 1.2: General action—Action on structures exposed to fire.” Eurocode 1, Brussels, Belgium.
- European Committee for Standardization (CEN). (2004). “Design of concrete structures. Part 1.2: General rules—Structural fire design.” Eurocode 2, Brussels, Belgium.
- European Committee for Standardization (CEN). (2005). “Design of steel structures. Part 1.2: General rules—Structural fire design.” Eurocode 3, Brussels, Belgium
- Garlock M., Glaasman J., and Labbouz S. (2013) “Elevated Temperature Properties of A588 Weathering Steel.” CAIT – Rutgers, Report CAIT-UTC-021
- Garlock M., Ignacio Paya-Zaforteza, Venkatesh Kodur, Li Gu, Fire hazard in bridges: Review, assessment and repair strategies, Engineering Structures, Volume 35, 2012, Pages 89-98, ISSN 0141-0296, <http://dx.doi.org/10.1016/j.engstruct.2011.11.002>.
- Gong, X., and Agrawal, A. K. (2015). “Numerical Simulation of Fire Damage to a Long-Span Truss Bridge.” J. Bridge Eng. [https://doi.org/10.1061/\(ASCE\)BE.1943-5592.0000707](https://doi.org/10.1061/(ASCE)BE.1943-5592.0000707)
- Gong, X., and Agrawal, A. K. (2016). “Safety of Cable-Supported Bridges during Fire Hazards”. J. Bridge Eng. [https://doi.org/10.1061/\(ASCE\)BE.1943-5592.0000870](https://doi.org/10.1061/(ASCE)BE.1943-5592.0000870)
- Kodur, V., Aziz, E., and Dwaikat, M. (2013). ”Evaluating Fire Resistance of Steel Girders in Bridges.” J. Bridge Eng., 18(7), 633–643.

Kodur, V., Dwaikat M., Fike, R. (2010). "High-Temperature Properties of Steel for Fire Resistance Modeling of Structures." J. Mat. in Civil Eng. [https://doi.org/10.1061/\(ASCE\)MT.1943-5533.0000041](https://doi.org/10.1061/(ASCE)MT.1943-5533.0000041)

Krishnamoorthy, R.R., & Bailey,C. (2009). Temperature distribution of intumescent coated steel frame connection at elevated temperature. Manchester.

Lee, George C., Satish B. Mohan, Chao Huang, & Bastam N. Fard. (2013) *A Study of U.S. Bridge Failures (1980-2012)*. Tech. no. 13-0008. U.S. Department of Transportation Federal Highway Administration. University at Buffalo, State University of New York: MCEER <<https://mceer.buffalo.edu/pdf/report/13-0008.pdf>>.

Mills, K.C., Su, Y., Li, Z., and Brooks, R.F. (2004). "Equations for the Calculation of the Thermo-physical Properties of Stainless Steel". ISIJ International. Vol. 44 (2004) No. 10 P 1661-1668. <http://doi.org/10.2355/isijinternational.44.1661>

Mizutani, Y., Yoshii, K., Chijiwa, R., Ishibashi, K., Watanabe, Y., and Yoshida, Y. (2004): Nippon Steel Technical Report: "590MPa Class Fire-Resistant Steel for Building Structural Use," Report No. 90, July 2004.

Wainman, D.E., and Kirby, B.R. (1987). "Compendium of UK Standard Fire Test Data, Unprotected Structural Steel – 1," British Steel Corporation Ref. No. RS/RSC/S10328/1/98/B, Swinden Laboratories, Rotherdam.

Wright, W., Lattimer, B., Woodworth, M., Nahid, M., and Sotelino, E. (2013). "Highway Bridge Fire Hazard Assesment, Draft Final Report." Virginia Polytechnic Institute and State University. TRB Project No. 12-85. Blacksburg, VA.

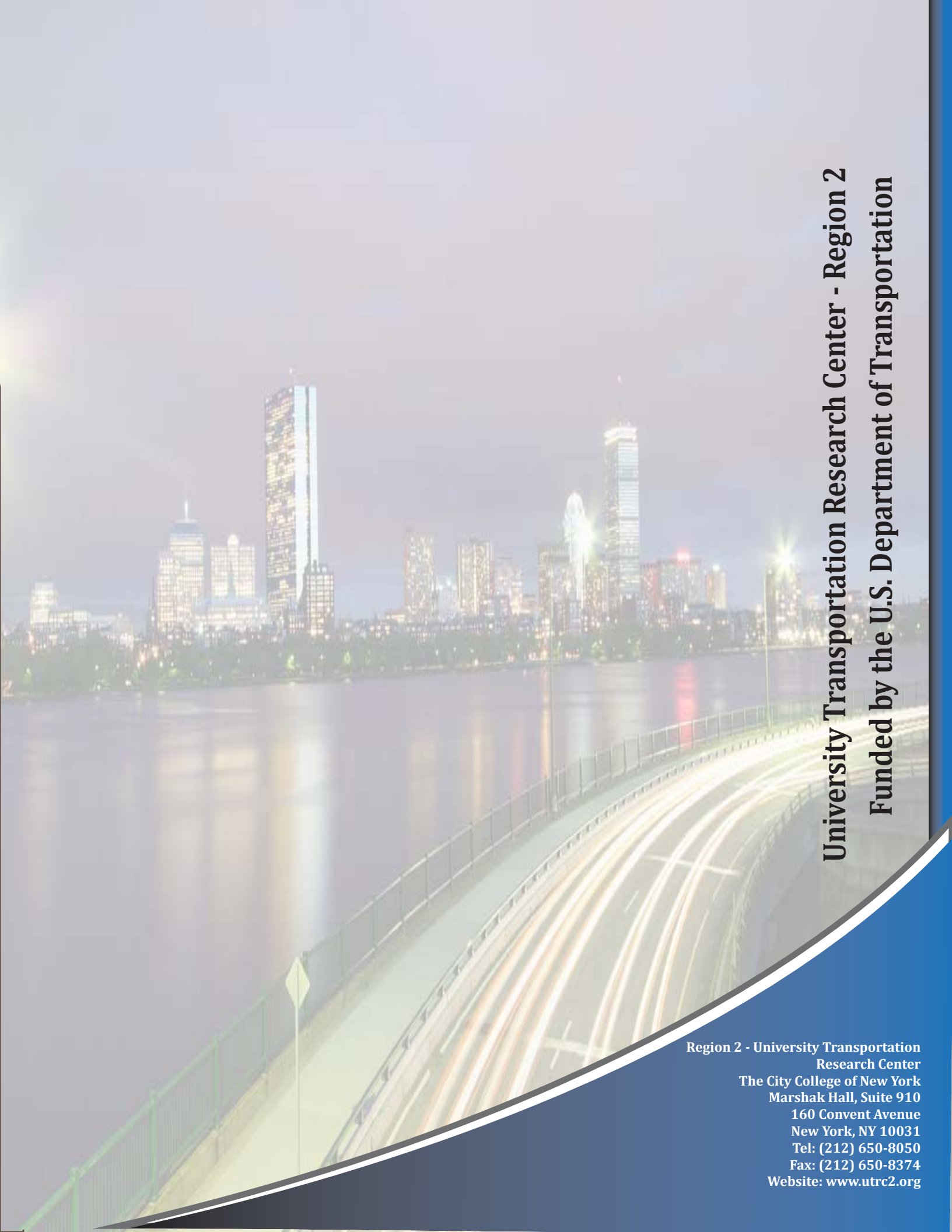
A long-exposure photograph of a city skyline at night, reflected in a body of water. In the foreground, a bridge or highway has light trails from moving vehicles. The sky is dark, and the city lights are bright and colorful.

University Transportation Research Center - Region 2
Funded by the U.S. Department of Transportation

**Region 2 - University Transportation
Research Center**
The City College of New York
Marshak Hall, Suite 910
160 Convent Avenue
New York, NY 10031
Tel: (212) 650-8050
Fax: (212) 650-8374
Website: www.utrc2.org